

MML固定放大倍率系列

MML高分辨率5M系列

这是所有 MML 系列里对比度和 NA 最佳的高分辨率型号。镜头结合高像素相机，尤其是新品 5 百万传感器，实现更高画质。

- MML系列最高画质型号
- 支持5百万像素 (3.34 μm /像素)
* 除了MML4-HR65DVI-5M
- 采用内反射散光设计和降噪过滤器, 减少热点
- 多数型号可变孔径
- 超低失真



型号	放大倍率	O/I	物距	分辨率	景深	NA	有效FNo	TV失真	最大可兼容相机规格	重量
MML03-HR65D-5M	×0.3	219.7mm	65.1mm	15.7 μm	6.2mm	0.021	7	0.0001或更低	2/3 “	202g
MML03-HR65-5M	×0.3	219.7mm	65.1mm	15.7 μm	6.2mm	0.021	7	0.0001或更低	2/3 “	198g
MML05-HR65DVI-5M	×0.5	219.8mm	65.3mm	9.3 μm ~ 41 μm	2.2mm ~ 9.8mm	0.036 ~ 0.008	7 ~ 30.6	0.0001或更低	2/3 “	210g
MML05-HR65VI-5M	×0.5	219.8mm	65.3mm	9.3 μm ~ 41 μm	2.2mm ~ 9.8mm	0.036 ~ 0.008	7 ~ 30.6	0.0001或更低	2/3 “	210g
MML1-HR65DVI-5M	×1	167.5mm	65mm	4.7 μm ~ 19 μm	0.56mm ~ 2.2mm	0.071 ~ 0.018	7 ~ 28	0.0002或更低	2/3 “	140g
MML1-HR65VI-5M	×1	167.5mm	65mm	4.7 μm ~ 19 μm	0.56mm ~ 2.2mm	0.071 ~ 0.018	7 ~ 28	0.0002或更低	2/3 “	135g
MML2-HR65DVI-5M	×2	185mm	65mm	2.4 μm ~ 15.3 μm	0.15mm ~ 0.9mm	0.14 ~ 0.022	7.3 ~ 44.9	0.0004或更低	2/3 “	200g
MML2-HR65VI-5M	×2	185mm	65mm	2.4 μm ~ 15.3 μm	0.15mm ~ 0.9mm	0.14 ~ 0.022	7.3 ~ 44.9	0.0004或更低	2/3 “	190g
MML3-HR65DVI-5M	×3	209.5mm	65mm	2.1 μm ~ 10.5 μm	0.085mm ~ 0.42mm	0.157 ~ 0.032	9.6 ~ 47.5	0.0001或更低	2/3 “	280g
MML3-HR65VI-5M	×3	209.5mm	65mm	2.1 μm ~ 10.5 μm	0.085mm ~ 0.42mm	0.157 ~ 0.032	9.6 ~ 47.5	0.0001或更低	2/3 “	275g
MML4-HR65DVI-5M	×4	225.1mm	65mm	2 μm ~ 8.2 μm	0.06mm ~ 0.24mm	0.167 ~ 0.041	12.1 ~ 48.6	0.0001或更低	2/3 “	290g
MML4-HR65VI-5M	×4	225.1mm	65mm	2 μm ~ 8.2 μm	0.06mm ~ 0.24mm	0.167 ~ 0.041	12.1 ~ 48.6	0.0001或更低	2/3 “	285g
MML014-HR110D-5M	×0.14	300mm	110mm	19.3 μm	16.4mm	0.018	4	-0.01%或更低	2/3 “	730g
MML03-HR110D-5M	×0.3	269.9mm	110mm	15.7 μm	6.2mm	0.021	7	0.02%或更低	2/3 “	212g
MML03-HR110-5M	×0.3	269.9mm	110mm	15.7 μm	6.2mm	0.021	7	0.02%或更低	2/3 “	209g

MML03-HR65D-5M

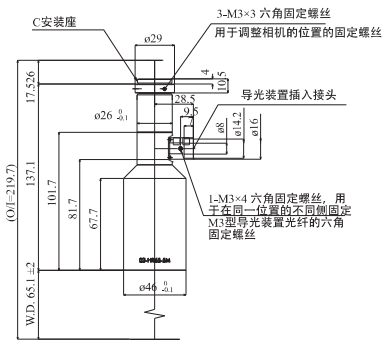

MML03-HR65-5M

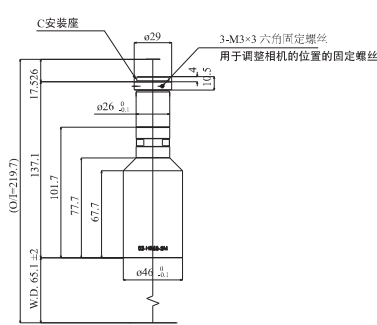

MML05-HR65DVI-5M

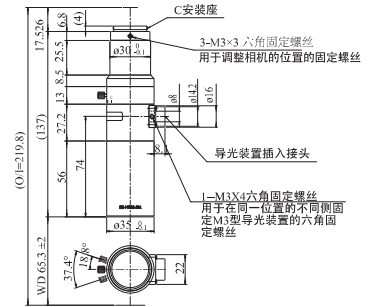

MML05-HR65VI-5M

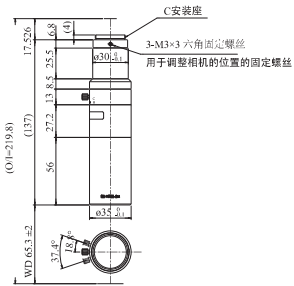

MML1-HR65DVI-5M

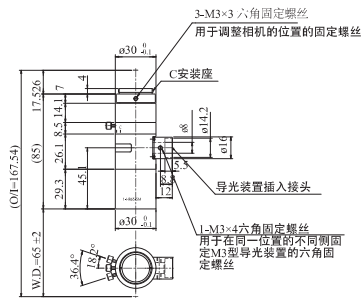

MML1-HR65VI-5M

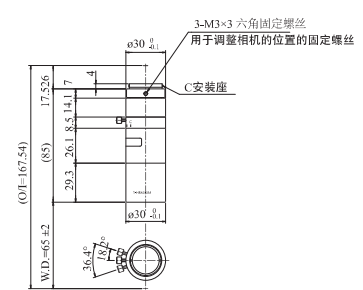

MML2-HR65DVI-5M

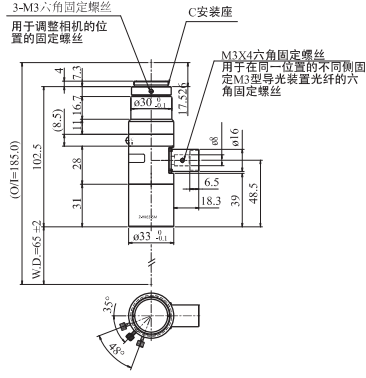

MML2-HR65VI-5M

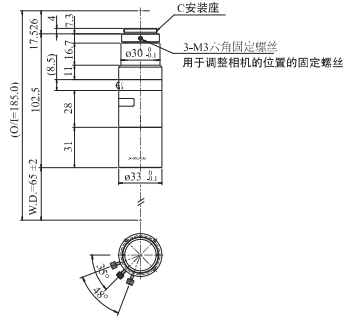

MML3-HR65DVI-5M

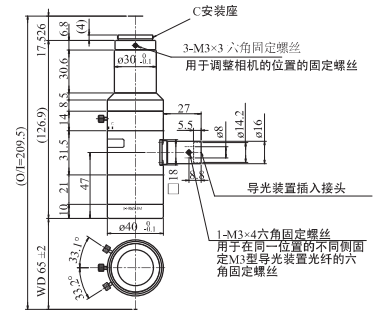

MML3-HR65VI-5M

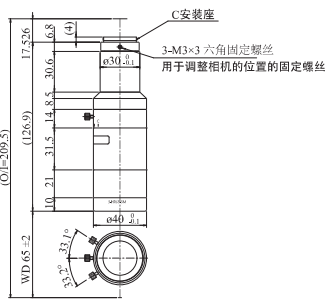

MML4-HR65DVI-5M

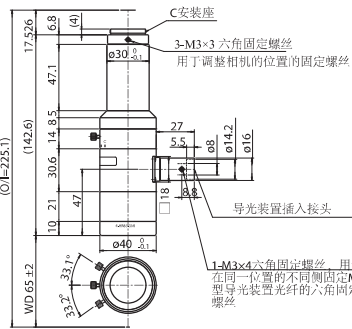

MML4-HR65VI-5M

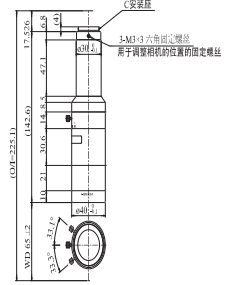

MML014-HR110D-5M

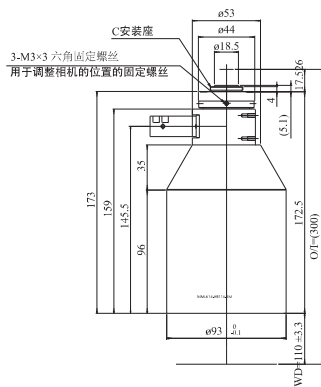

MML03-HR110D-5M

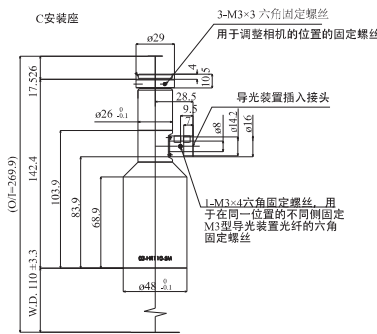

MML03-HR110-5M

